

Varenummer: 588U2E613BB0671

Beskrivelse: Magnetventil type U2E613.BB0.671 2/2 NC
24 VDC dyse 13,0 hus i Messing Portstr. G1/2"

Mål

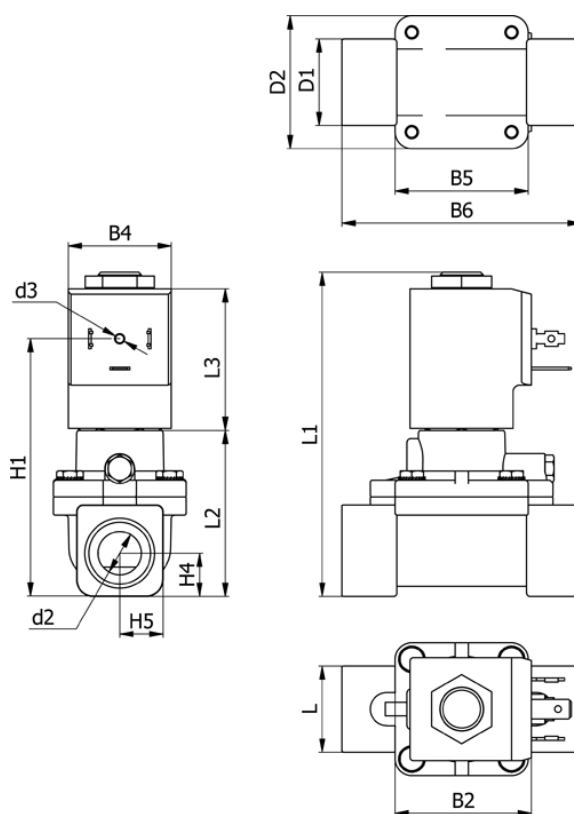

B2 = 41	Flow = 35	Spænding = 24 VDC
B4 = 31	H1 = 77.5	Ventilfunktion = 2/2 NC
B5 = 40	H4 = 13	
B6 = 72	H5 = 13	
D1 = 26	L1 = 97.6	
d2 = G1/2"	L2 = 50	
D2 = 40	L3 = 42.5	
d3 = M3x4	Lysning = 13.0	